

100% PURE CRANK FROM PAUL



VERY IMPORTANT!

These cranks have ISO spindle tapers. Campagnolo uses this taper.

Recommended bottom brackets:

- Phil Wood 110.5 Campy Taper
- Campagnolo 111 Track
- Campagnolo 111 ACH

-Although it is possible to use a JIS taper bottom bracket (Shimano and most Asian BB's), it will not go into the crank arm far enough for a proper and safe fit. Any damage done by using JIS taper bottom brackets will not be covered by any warranties.

-Requires 1/8" chain.

-Check chainstay clearance before installing cranks as per diagram below.

*Paul Component MTB cranks are quite narrow and will not fit all frames. BE SURE AND CHECK BEFORE INSTALLATION!

Torque setting:

- Bottom Bracket Screws: 300in/lbs
- Chain Ring Screw: 100in/lbs

ROAD

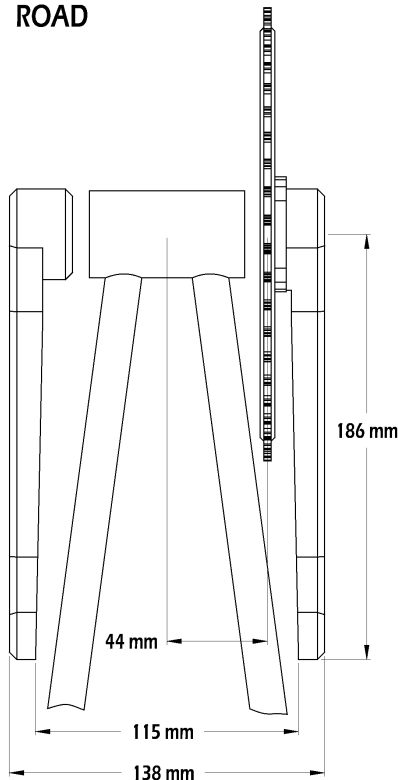

MOUNTAIN

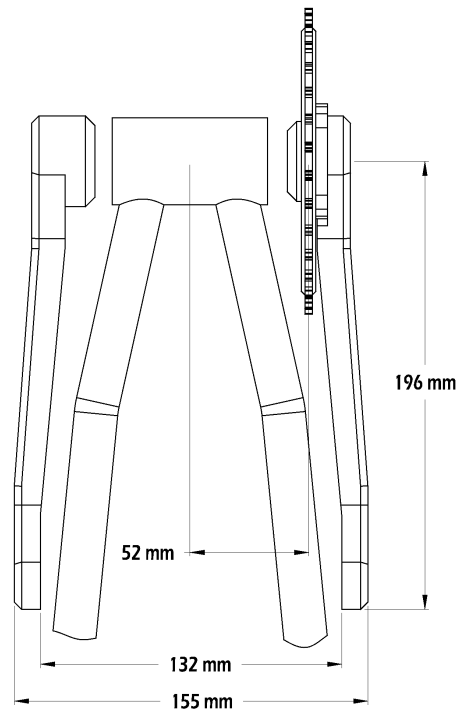

PAUL Component Engineering
11204 Midway
Chico, CA 95928 USA
www.paulcomp.com
(530)345-4371